

Features

- Spread spectrum for EMI reduction
 - Wide spread % option
 - Center spread: from $\pm 0.125\%$ to $\pm 1\%$, $\pm 0.125\%$ step size
 - Down spread: -0.25% to -2% with -0.25% step size
 - Spread profile option: Triangular, Hershey-kiss, Random
- Programmable rise/fall time for EMI reduction: 8 options, 0.25 to 40 ns
- Any frequency between 1 MHz and 150 MHz accurate to 6 decimal places
- 100% pin-to-pin drop-in replacement to quartz-based XO's
- Excellent total frequency stability as low as ± 20 ppm
- Operating temperature from -55°C to 125°C .
- Low power consumption of 4.0 mA typical at 1.8V
- Pin1 modes: Standby, output enable, or spread disable
- Fast startup time of 5 ms
- LVC MOS output
- Industry-standard packages
 - QFN: 2.0×1.6 , 2.5×2.0 , $3.2 \times 2.5 \text{ mm}^2$
- RoHS and REACH compliant, Pb-free, Halogen-free and Antimony-free

Applications

- ADAS camera
- ADAS ECU
- High speed serial link

Electrical Specifications

Table 1. Electrical Characteristics

All Min and Max limits are specified over temperature and rated operating voltage with 15 pF output load unless otherwise stated. Typical values are at 25°C and 3.3V supply voltage.

Parameters	Symbol	Min.	Typ.	Max.	Unit	Condition
Frequency Range						
Output Frequency Range	f	1	–	150	MHz	
Frequency Stability and Aging						
Frequency Stability	F_stab	-20	–	+20	ppm	Inclusive of initial tolerance at 25°C , 1st year aging at 25°C , and variations over operating temperature, rated power supply voltage. Spread = Off.
		-25	–	+25	ppm	
		-50	–	+50	ppm	
Operating Temperature Range						
Operating Temperature Range	T_use	-40	–	+85	$^{\circ}\text{C}$	Industrial, AEC-Q100 Grade 3
		-40	–	+105	$^{\circ}\text{C}$	Extended Industrial, AEC-Q100 Grade 2
		-40	–	+125	$^{\circ}\text{C}$	Automotive, AEC-Q100 Grade 1
		-55	–	+125	$^{\circ}\text{C}$	Extended Automotive, AEC-Q100
Supply Voltage and Current Consumption						
Supply Voltage	Vdd	1.62	1.8	1.98	V	
		2.25	2.5	2.75	V	
		2.52	2.8	3.08	V	
		2.7	3.0	3.3	V	
		2.97	3.3	3.63	V	
		2.25	–	3.63	V	
Current Consumption	Idd	–	6.5	9.0	mA	No load condition, f = 148.5 MHz, Vdd = 2.5V to 3.3V
		–	5.5	7.0	mA	No load condition, f = 148.5 MHz, Vdd = 1.8V
OE Disable Current	I_OD	–	5.5	–	mA	f = 148.5 MHz, Vdd = 2.5V to 3.3V, OE = GND, Output in high-Z state
		–	5.1	–	mA	f = 148.5 MHz, Vdd = 1.8V, OE = GND, Output in high-Z state
Standby Current	I_std	–	2.6	–	μA	$\overline{\text{ST}}$ = GND, Vdd = 2.5V to 3.3V, Output is weakly pulled down
		–	0.9	–	μA	$\overline{\text{ST}}$ = GND, Vdd = 1.8V, Output is weakly pulled down

Table 1. Electrical Characteristics (continued)

Parameters	Symbol	Min.	Typ.	Max.	Unit	Condition
LVCMS Output Characteristics						
Duty Cycle	DC	45	–	55	%	
Rise/Fall Time	Tr, Tf	–	1.3	2.5	ns	Vdd = 1.8V, 20% - 80%, default derive strength
		–	–	2	ns	Vdd = 2.25V - 3.63V, 20% - 80%, default derive strength
Output High Voltage	VOH	90%	–	–	Vdd	I _{OH} = -4 mA (Vdd = 3.0V or 3.3V) I _{OH} = -3 mA (Vdd = 2.8V and Vdd = 2.5V) I _{OH} = -2 mA (Vdd = 1.8V)
Output Low Voltage	VOL	–	–	10%	Vdd	I _{OL} = 4 mA (Vdd = 3.0V or 3.3V) I _{OL} = 3 mA (Vdd = 2.8V and Vdd = 2.5V) I _{OL} = 2 mA (Vdd = 1.8V)
Input Characteristics						
Input High Voltage	VIH	70%	–	–	Vdd	Pin 1, OE or \overline{ST}
Input Low Voltage	VIL	–	–	30%	Vdd	Pin 1, OE or \overline{ST}
Input Pull-up Impedance	Z _{in}	–	87	–	kΩ	Pin 1, OE logic high or logic low, or \overline{ST} logic high
		–	8	–	MΩ	Pin 1, \overline{ST} logic low
Startup and Resume Timing						
Startup Time	T _{start}	–	–	5	ms	Measured from the time Vdd reaches its rated minimum value
Enable/Disable Time	T _{oe}	–	–	215	ns	f = 148.5 MHz. For other frequencies, T _{oe} = 100 ns + 3 * cycles
Resume Time	T _{resume}	–	–	5	ms	Measured from the time ST pin crosses 50% threshold
Spread Enable Time	T _{sde}	–	–	4	μs	Measured from the time SD pin crosses 50% threshold
Spread Disable Time	T _{sdde}	–	–	50	μs	Measured from the time SD pin crosses 50% threshold
Jitter						
Cycle-to-cycle jitter	T _{ccj}	–	10.5	–	ps	f = 148.5 MHz, Vdd = 2.5 to 3.3V, Spread = ON(or OFF)
		–	12.5	–	ps	f = 148.5 MHz, Vdd = 1.8V, Spread = ON(or OFF)

Table 2. Spread Spectrum %^[1]

Ordering Code	Center Spread (%)	Down Spread (%)
A	±0.125	-0.25
B	±0.250	-0.50
C	±0.390	-0.78
D	±0.515	-1.04
E	±0.640	-1.29
F	±0.765	-1.55
G	±0.905	-1.84
H	±1.030	-2.10
I	±1.155	-2.36
J	±1.280	-2.62
K	±1.420	-2.91
L	±1.545	-3.18
M	±1.670	-3.45
N	±1.795	-3.71
O	±1.935	-4.01
P	±2.060	-4.28

Table 3. Spread Profile^[2]

Spread Profile
Triangular
Hershey-kiss
Random

Notes:

1. Contact JYJE for availability of these spread options at -40 to 105°C, -40 to 125°C or -55 to 125°C temperature ranges.
2. In both Triangular and Hershey-kiss profiles, modulation rate is employed with a frequency of ~31.25 kHz. In random profile, modulation rate is ~ 8.6 kHz

Table 4. Pin Description

Pin	Symbol		Functionality
1	OE/ $\overline{\text{ST}}$ / NC/ SD	Output Enable	H ^[3] : specified frequency output L: output is high impedance. Only output driver is disabled.
		Standby	H ^[3] : specified frequency output L: output is low (weak pull down). Device goes to sleep mode. Supply current reduced to I _{std} .
		No Connect	Pin1 has no function (Any voltage between 0 and Vdd or Open)
		Spread Disable	H: Spread = ON L: Spread = OFF
2	GND	Power	Electrical ground
3	OUT	Output	Oscillator output
4	VDD	Power	Power supply voltage ^[4]

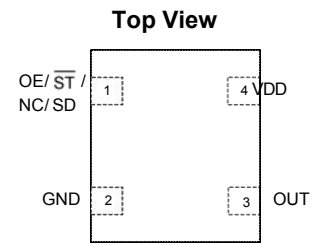

Figure 1. Pin Assignments

Notes:

- In OE or $\overline{\text{ST}}$ mode, a pull-up resistor of 10 kΩ or less is recommended if pin 1 is not externally driven. If pin 1 needs to be left floating, use the NC option.
- A capacitor of value 0.1 μF or higher between Vdd and GND is required.

Table 5. Absolute Maximum Limits

Attempted operation outside the absolute maximum ratings may cause permanent damage to the part. Actual performance of the IC is only guaranteed within the operational specifications, not at absolute maximum ratings.

Parameter	Min.	Max.	Unit
Storage Temperature	-65	150	°C
Vdd	-0.5	4	V
Electrostatic Discharge	–	2000	V
Soldering Temperature (follow standard Pb free soldering guidelines)	–	260	°C
Junction Temperature ^[5]	–	150	°C

Note:

- Exceeding this temperature for extended period of time may damage the device.

Table 6. Maximum Operating Junction Temperature^[6]

Max Operating Temperature (ambient)	Maximum Operating Junction Temperature
70°C	80°C
85°C	95°C

Note:

- Datasheet specifications are not guaranteed if junction temperature exceeds the maximum operating junction temperature.

Table 7. Environmental Compliance

Parameter	Condition/Test Method
Mechanical Shock	MIL-STD-883F, Method 2002
Mechanical Vibration	MIL-STD-883F, Method 2007
Temperature Cycle	JESD22, Method A104
Solderability	MIL-STD-883F, Method 2003
Moisture Sensitivity Level	MSL1 @ 260°C

Timing Diagrams

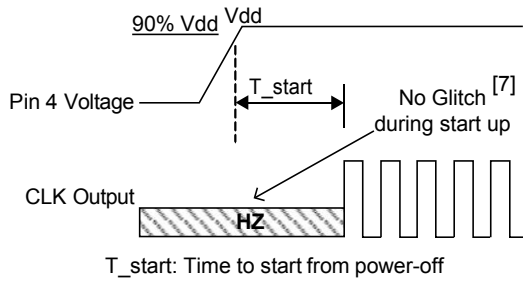

Figure 1. Startup Timing

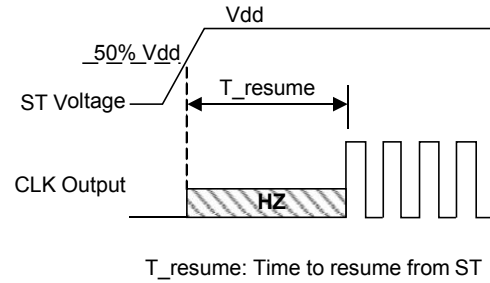

Figure 2. Standby Resume Timing (ST Mode Only)

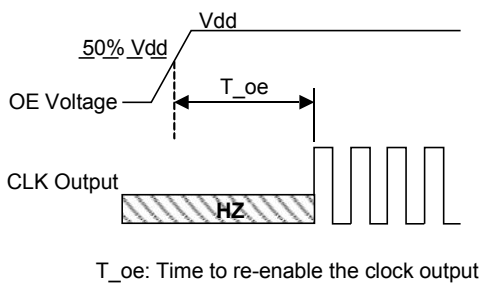

Figure 3. OE Enable Timing (OE Mode Only)

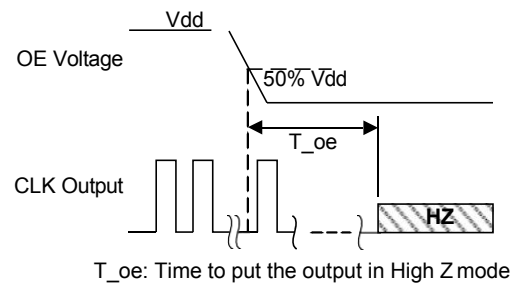

Figure 4. OE Disable Timing (OE Mode Only)

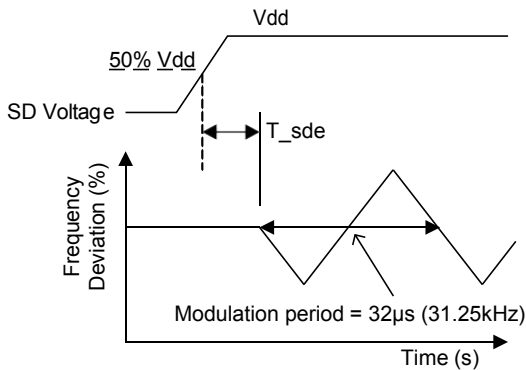

Figure 5. SD Enable Timing (SD Mode Only)

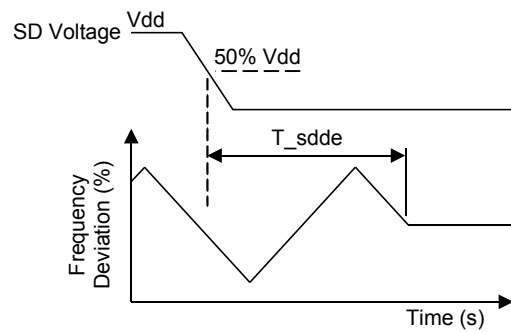

Figure 6. SD Disable Timing (SD Mode Only)

Note:

7. JYJE9025 has "no runt" pulses and "no glitch" output during startup or resume.

Rise/Fall Time (20% to 80%) vs C_{LOAD} Tables

Table 8. V_{dd} = 1.8V Rise/Fall Times for Specific C_{LOAD}

Rise/Fall Time Typ (ns)					
Drive Strength \ C _{LOAD}	5 pF	15 pF	30 pF	45 pF	60 pF
L	6.16	11.61	22.00	31.27	39.91
A	3.19	6.35	11.00	16.01	21.52
R	2.11	4.31	7.65	10.77	14.47
B	1.65	3.23	5.79	8.18	11.08
T	0.93	1.91	3.32	4.66	6.48
E	0.78	1.66	2.94	4.09	5.74
U	0.70	1.48	2.64	3.68	5.09
F or "-": default	0.65	1.30	2.40	3.35	4.56

Table 9. V_{dd} = 2.5V Rise/Fall Times for Specific C_{LOAD}

Rise/Fall Time Typ (ns)					
Drive Strength \ C _{LOAD}	5 pF	15 pF	30 pF	45 pF	60 pF
L	4.13	8.25	12.82	21.45	27.79
A	2.11	4.27	7.64	11.20	14.49
R	1.45	2.81	5.16	7.65	9.88
B	1.09	2.20	3.88	5.86	7.57
T	0.62	1.28	2.27	3.51	4.45
E or "-": default	0.54	1.00	2.01	3.10	4.01
U	0.43	0.96	1.81	2.79	3.65
F	0.34	0.88	1.64	2.54	3.32

Table 10. V_{dd} = 2.8V Rise/Fall Times for Specific C_{LOAD}

Rise/Fall Time Typ					
Drive Strength \ C _{LOAD}	5 pF	15 pF	30 pF	45 pF	60 pF
L	3.77	7.54	12.28	19.57	25.27
A	1.94	3.90	7.03	10.24	13.34
R	1.29	2.57	4.72	7.01	9.06
B	0.97	2.00	3.54	5.43	6.93
T	0.55	1.12	2.08	3.22	4.08
E or "-": default	0.44	1.00	1.83	2.82	3.67
U	0.34	0.88	1.64	2.52	3.30
F	0.29	0.81	1.48	2.29	2.99

Table 11. V_{dd} = 3.0V Rise/Fall Times for Specific C_{LOAD}

Rise/Fall Time Typ (ns)					
Drive Strength \ C _{LOAD}	5 pF	15 pF	30 pF	45 pF	60 pF
L	3.60	7.21	11.97	18.74	24.30
A	1.84	3.71	6.72	9.86	12.68
R	1.22	2.46	4.54	6.76	8.62
B	0.89	1.92	3.39	5.20	6.64
T or "-": default	0.51	1.00	1.97	3.07	3.90
E	0.38	0.92	1.72	2.71	3.51
U	0.30	0.83	1.55	2.40	3.13
F	0.27	0.76	1.39	2.16	2.85

Table 12. V_{dd} = 3.3V Rise/Fall Times for Specific C_{LOAD}

Rise/Fall Time Typ (ns)					
Drive Strength \ C _{LOAD}	5 pF	15 pF	30 pF	45 pF	60 pF
L	3.39	6.88	11.63	17.56	23.59
A	1.74	3.50	6.38	8.98	12.19
R	1.16	2.33	4.29	6.04	8.34
B	0.81	1.82	3.22	4.52	6.33
T or "-": default	0.46	1.00	1.86	2.60	3.84
E	0.33	0.87	1.64	2.30	3.35
U	0.28	0.79	1.46	2.05	2.93
F	0.25	0.72	1.31	1.83	2.61

Dimensions and Patterns

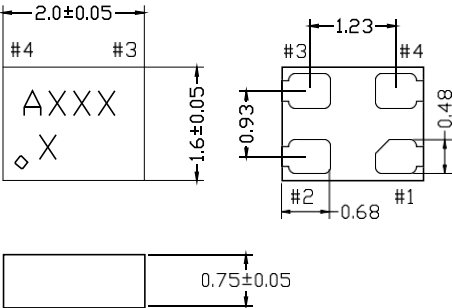
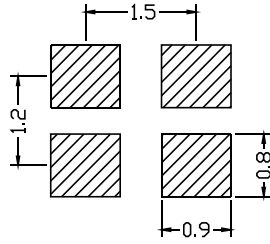
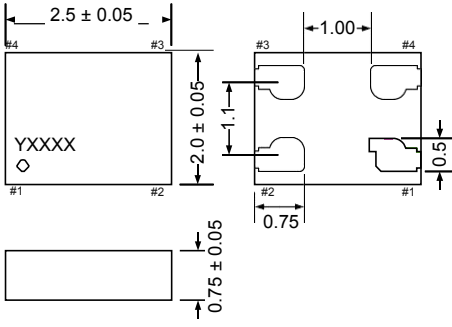
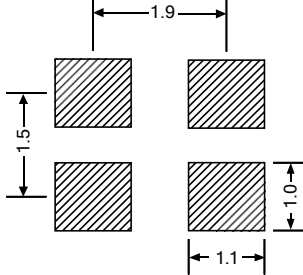
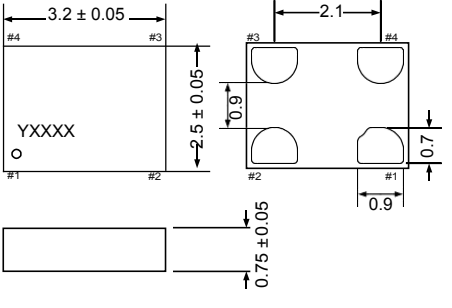
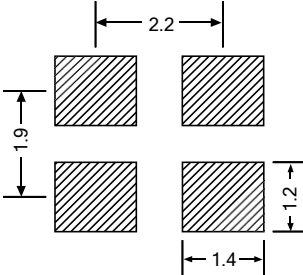
Package Size – Dimensions (Unit: mm) ^[9]	Recommended Land Pattern (Unit: mm) ^[9]
<p>2.0 x 1.6 x 0.75 mm</p> 	
<p>2.5 x 2.0 x 0.75 mm</p> 	
<p>3.2 x 2.5 x 0.75 mm</p> 	

Notes:

- 8. Top marking: Y denotes manufacturing origin and XXXX denotes manufacturing lot number. The value of "Y" will depend on the assembly location of the device.
- 9. A capacitor of value 0.1 μ F or higher between Vdd and GND is required.

Ordering Information

The Part No. Guide is for reference only. To customize and build an exact part number, use the JYJE **Part Number Generator**.

JYJE9025AA-71-18EA25.000625D

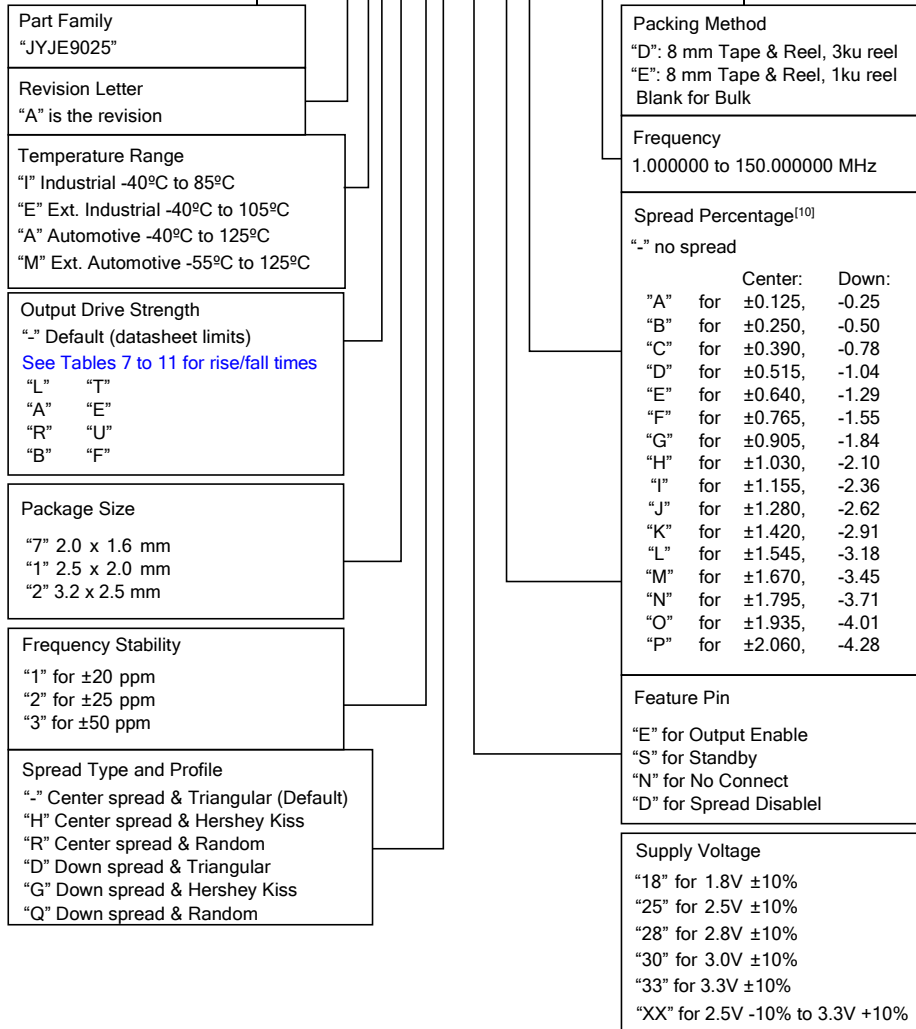

Notes:

- Contact JYJE for availability of these spread options at -40 to 105°C, -40 to 125°C or -55 to 125°C temperature ranges