

● Feature 特性

- ★TCX02016 4pin贴片晶振、晶体谐振器
- ★满足无铅焊接的回流温度曲线要求
- ★高精度、高频率稳定性、可靠性
- ★低功耗、低抖动
- ★降低电磁干扰（EMI）影响
- ★优良的耐环境特性，可达工业级温度
- ★包装：编带卷，3000pcs/卷



型号	Holder Type	OSC 5032
频率范围	Frequency Range	2.500MHz~54.000MHz
频率偏差	Frequency Toleranc (ΔF) at25°C	±0.5ppm~±2.5ppm
输入电压	Supply Voltage	1.8V~5.0V ±10%
工作温度范围	Operating Temperature Range	-20°C~+70°C to -40°C~+85°C
储存温度范围	Storage Temperature Range	-20°C~+60°C to -55°C~+125°C
占空比	Symmetry	40/60 Standald
输出	Output Load 5.0V	10 TTL or 15pF HCMOS
	Output Load 2.0V	10 TTL or 15pF HCMOS
消耗电流	Current Consumption 5.0V	1-36MHz=25mA Max
		36-70MHz=60mA Max
		70-125MHz=80mA Max
	Current Consumption 2.0V	1-36MHz=20mA Max
		36-70MHz=40mA Max
		70-125MHz=60mA Max
上升/下降时间	Rise/fall Time	10nS Max

●Mechanical Dimensions 外型尺寸

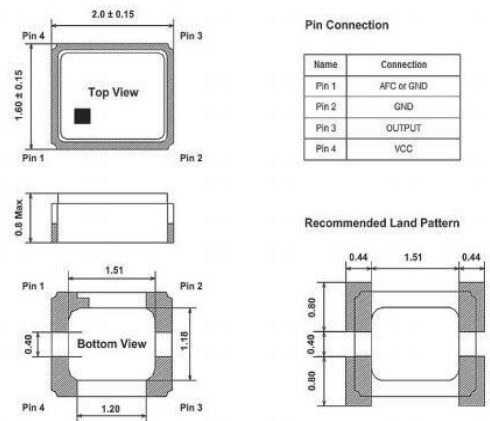

●Test Circuit 测试电路

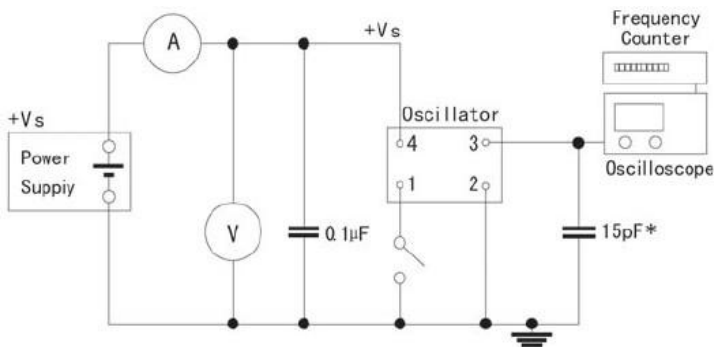

PIN	FUNCTION
1	N/C or Tri-state
2	Ground
3	Output
4	Vdd

●Reflow condition 回流焊条件

